

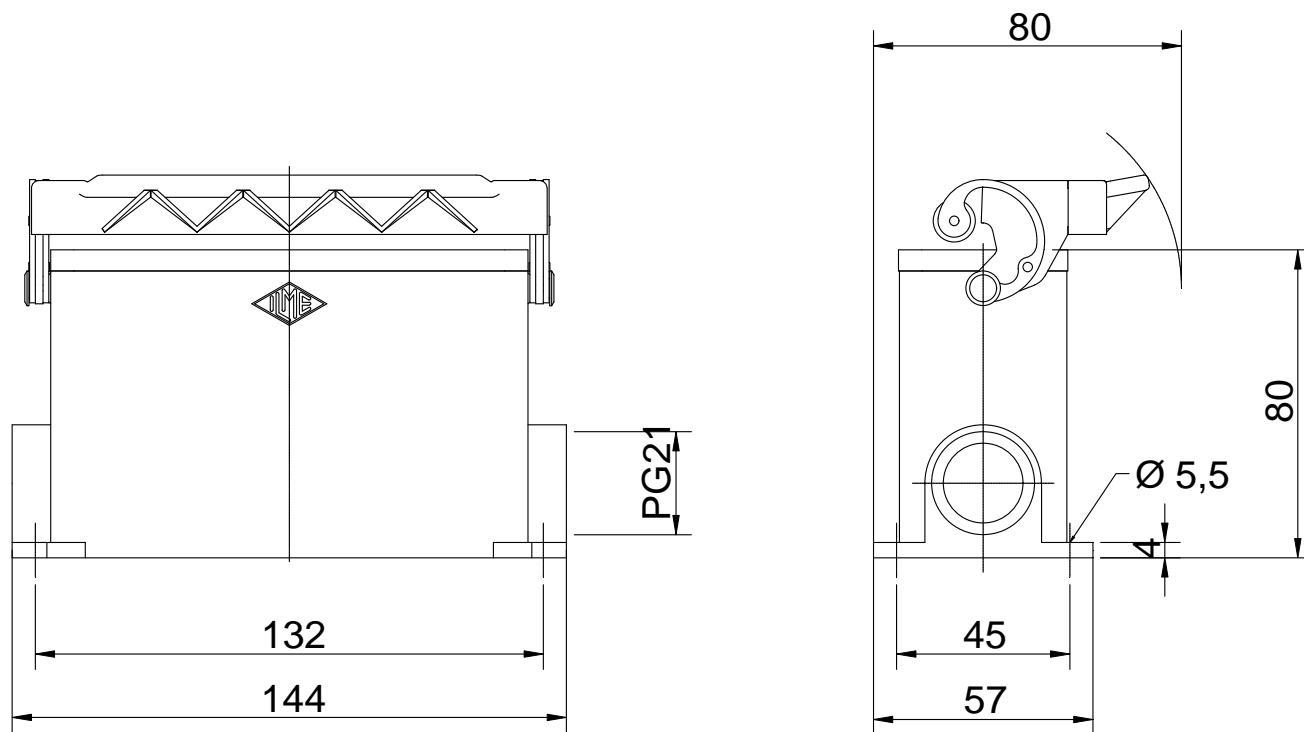

Diritti riservati All rights reserved



Date 04.01.2007	CMAP 16 L2	Scale	
Sign.	surface mounting h. 1 lev. PG21 ins.	1:2	